

Verdin

2,976 SQ.FT | 4 BEDROOM | 3 BATH | 2 BAY GARAGE

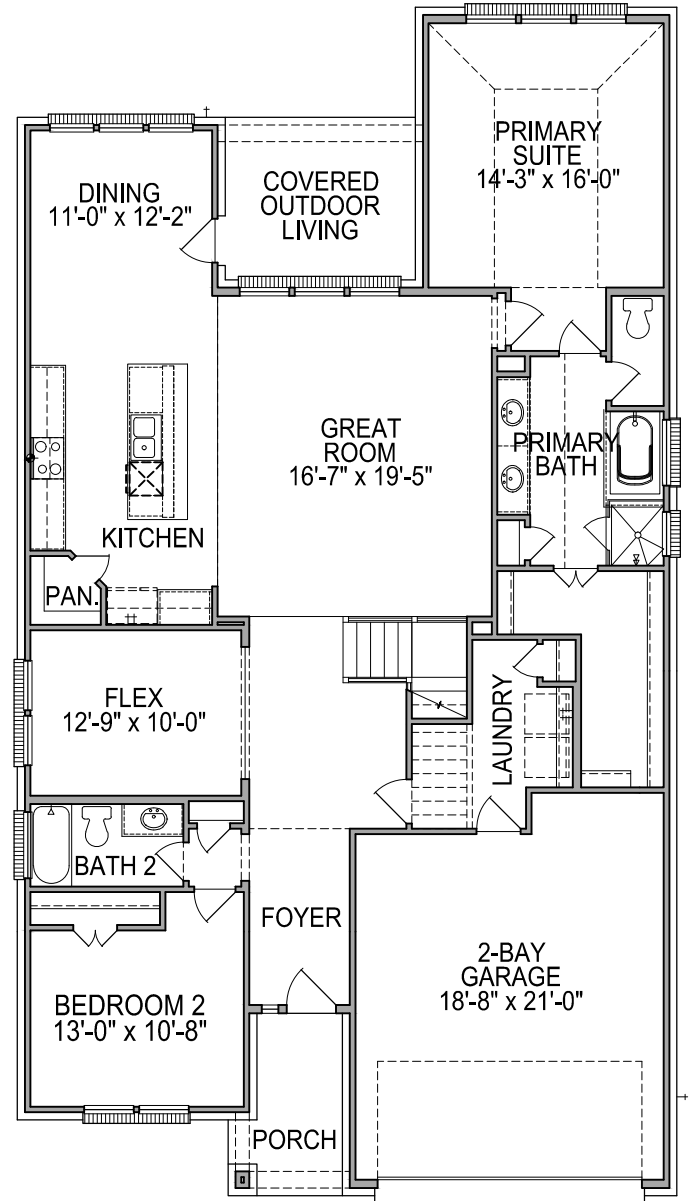

FIRST FLOOR PLAN

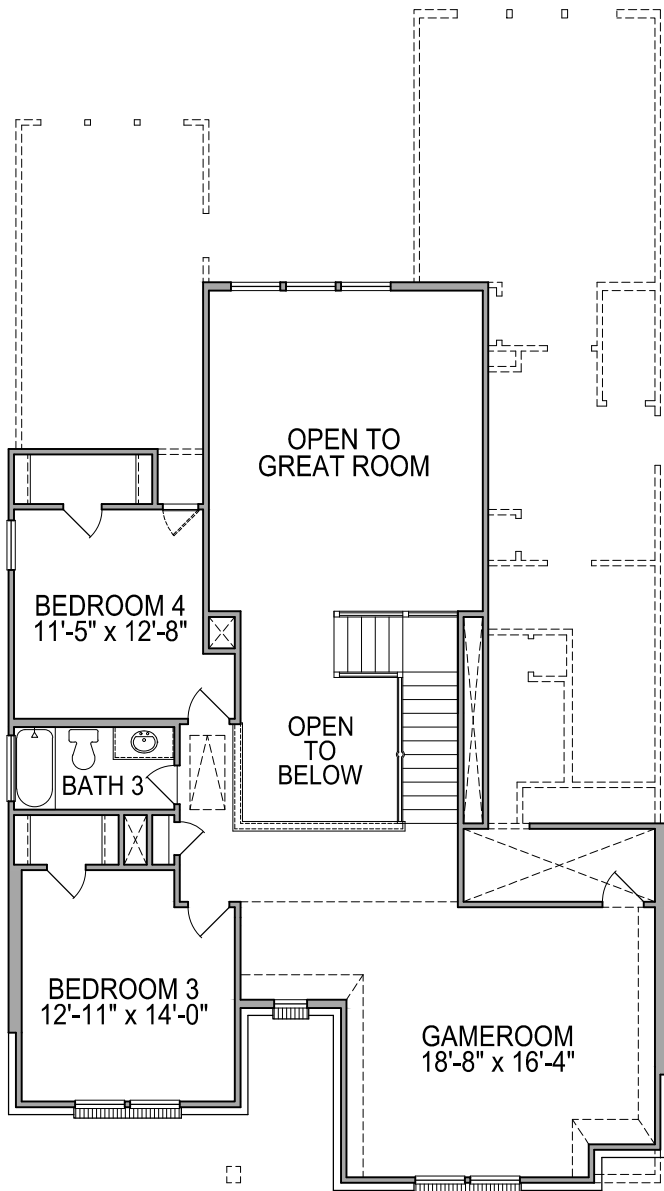

SECOND FLOOR PLAN

Verdin

2,976 SQ.FT | 4 BEDROOM | 3 BATH | 2 BAY GARAGE

Plan Options

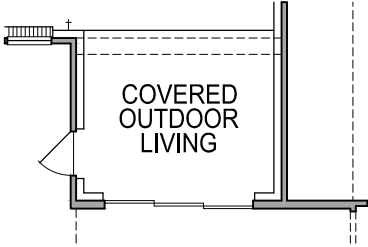

**FIRST FLOOR PLAN
OPT. #0790 SLIDERS
@ GREAT ROOM**

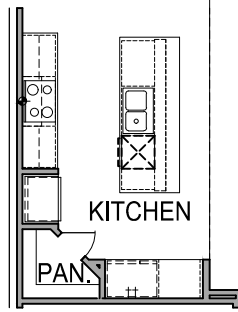

**FIRST FLOOR PLAN
OPT. #KITUPGSI 36" COOKTOP
w/ OVEN/MICRO TOWER
CONFIGURATION**

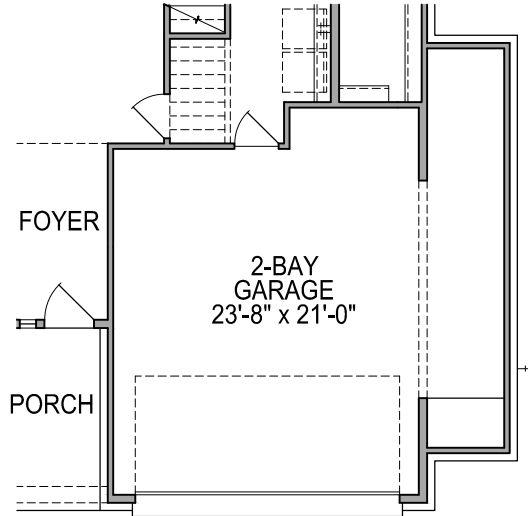

**FIRST FLOOR PLAN
OPT. #0613 5' GARAGE EXT.**

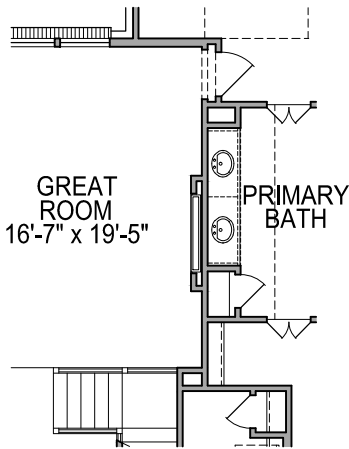

**FIRST FLOOR PLAN
OPT. #FRESC501
ELECTRIC FIREPLACE**

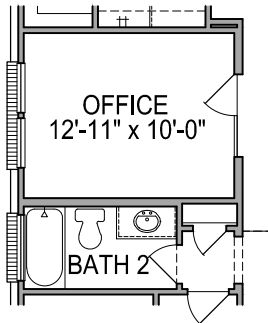

**FIRST FLOOR PLAN
OPT. #0569 OFFICE
FROM FLEX**

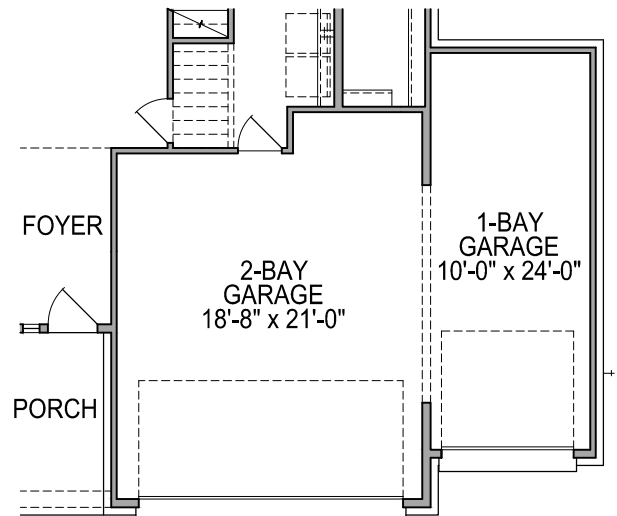

**FIRST FLOOR PLAN
OPT. #0593 1 BAY GARAGE**

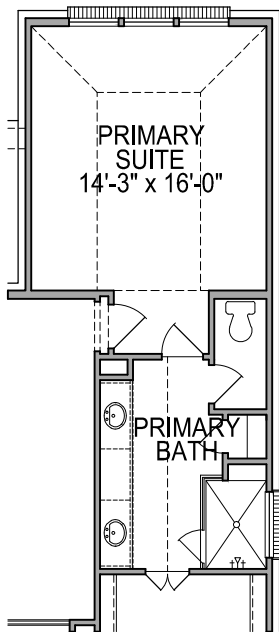

**FIRST FLOOR PLAN
OPT. #0072
LUXURY SHOWER**

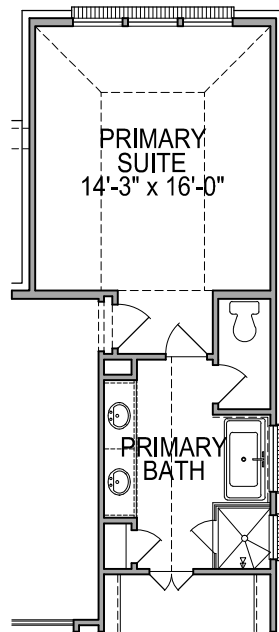

**FIRST FLOOR PLAN
OPT. #0073
5' FREE STANDING TUB**

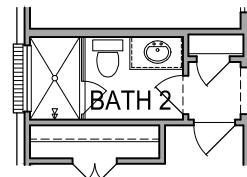

**FIRST FLOOR PLAN
OPT. #0155
SHOWER AT BATH 2**

Verdin

2,976 SQ.FT | 4 BEDROOM | 3 BATH | 2 BAY GARAGE

Plan Options

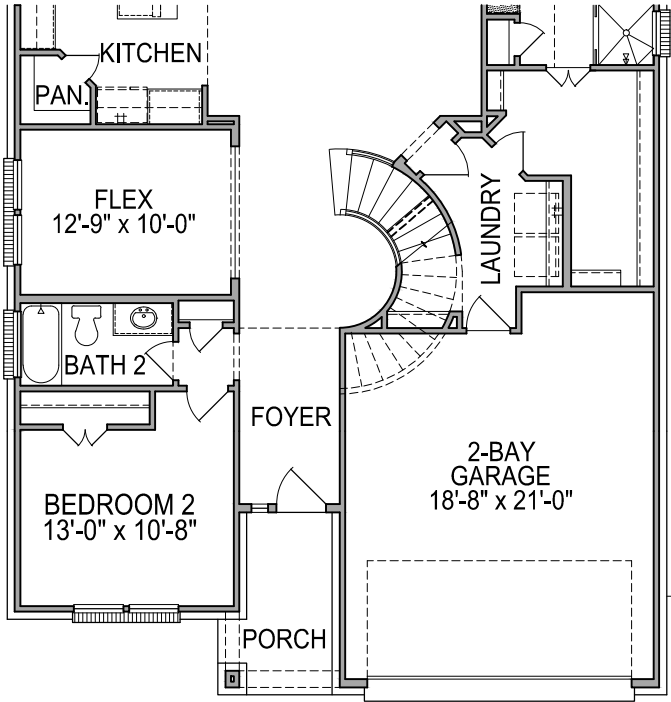

**FIRST FLOOR PLAN
OPT. #0113 CURVED STAIRS**

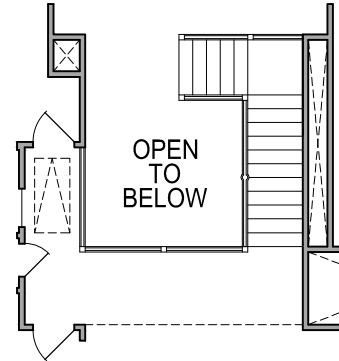

**SECOND FLOOR PLAN
OPT. #0050 RAILING**

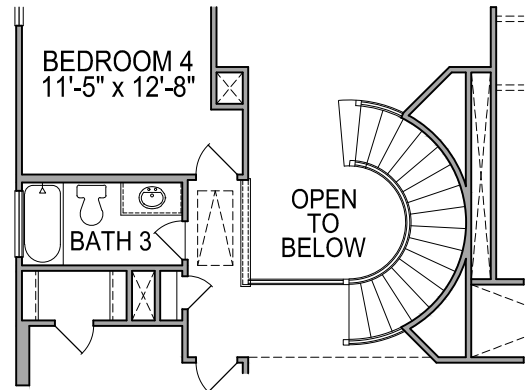

**SECOND FLOOR PLAN
OPT. #0113 CURVED STAIRS**

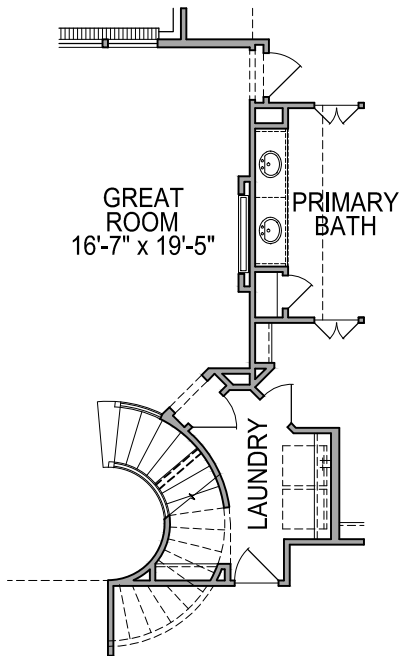

**FIRST FLOOR PLAN
OPT. #FRESC501
ELEC. FIREPLACE w/
OPT. #0113 CURVED STAIRS**

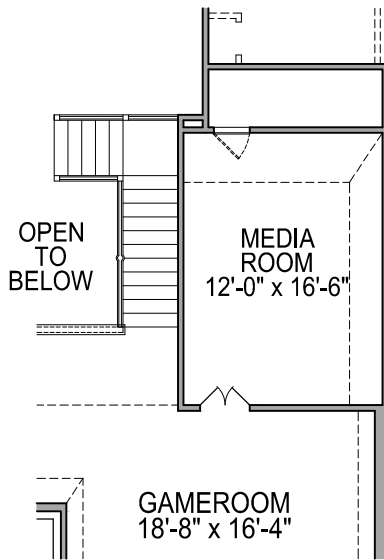

**SECOND FLOOR PLAN
OPT. #0526 MEDIA ROOM
FROM ATTIC**

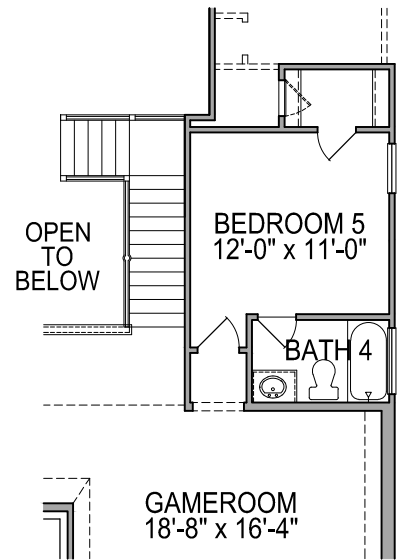

**SECOND FLOOR PLAN
OPT. #0094 BED 5/BATH 4
FROM ATTIC**

Verdin

2,976 SQ.FT | 4 BEDROOM | 3 BATH | 2 BAY GARAGE



EXTERIOR STYLE D



EXTERIOR STYLE E



EXTERIOR STYLE F
PAINTED BRICK



EXTERIOR STYLE H



EXTERIOR STYLE T

Life-Changing By Design

TriPointeHomes.com/Houston
L404

The prices of our homes, included features, plans, specifications, promotions/incentives, neighborhood build-out and available locations are subject to change without notice. Stated dimensions, square footage and acreage are approximate and should not be used as a representation of any home's or homesite's precise or actual size, location or orientation. There is no guarantee that any particular homesite or home will be available. No information or material herein is to be construed to be an offer or solicitation for sale. A Broker/Agent must register their client in person on client's first visit at each community for a Broker/Agent to receive a commission or referral fee, if available. Not all features and options are available in all homes. Unless otherwise expressly stated, homes do not come with hardscape, landscape, or other decorator items. Any photographs or renderings used herein reflect artists' conceptions and are for illustrative purposes only. Community maps, illustrations, plans and/or amenities reflect our current vision and are subject to change without notice. Maps not to scale. Photographs or renderings of people do not depict or indicate any preference regarding race, religion, gender, sexual orientation, disability, familial status, or national origin. Some amenities may not yet be constructed. Builder reserves the right to change the size, design, configuration and location of amenities not yet constructed and does not warrant the suitability thereof for any use or for any person. There is no guarantee that any particular homesite, home or common area will offer a view or that any particular view will be preserved. Views may also be altered by subsequent development, construction, and landscaping growth. A link to a third party website does not imply endorsement of that site nor any ability to control that site's privacy practices. Marketing promotions/incentives, if any, are subject to conditions or restrictions and are subject to change without notice. No warranty or guarantee is made regarding any particular area public school/school district or that any particular public school/school district will service any given community. Schools/school districts may change over time. Builder does not warrant the suitability of any trail for any use or for any person. Our name and the logos contained herein are registered trademarks of Tri Pointe Homes, Inc. and/or its subsidiaries. © 2021 Tri Pointe Homes, Inc. All rights reserved. For State Licensing and Notices, see <https://www.tripointehomes.com/statelicensenotices>.

LAST REVISED 11/11/24